

ASSEMBLY INSTRUCTIONS : FOOTING INSTALLATION

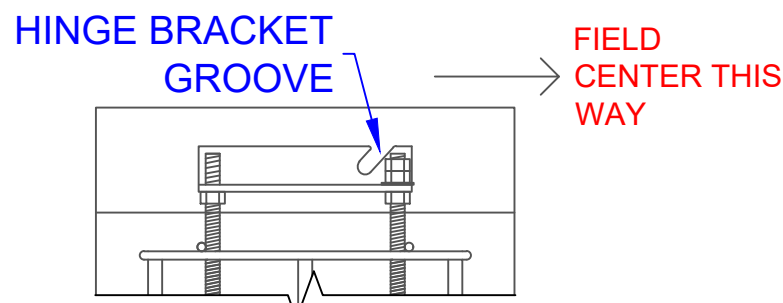
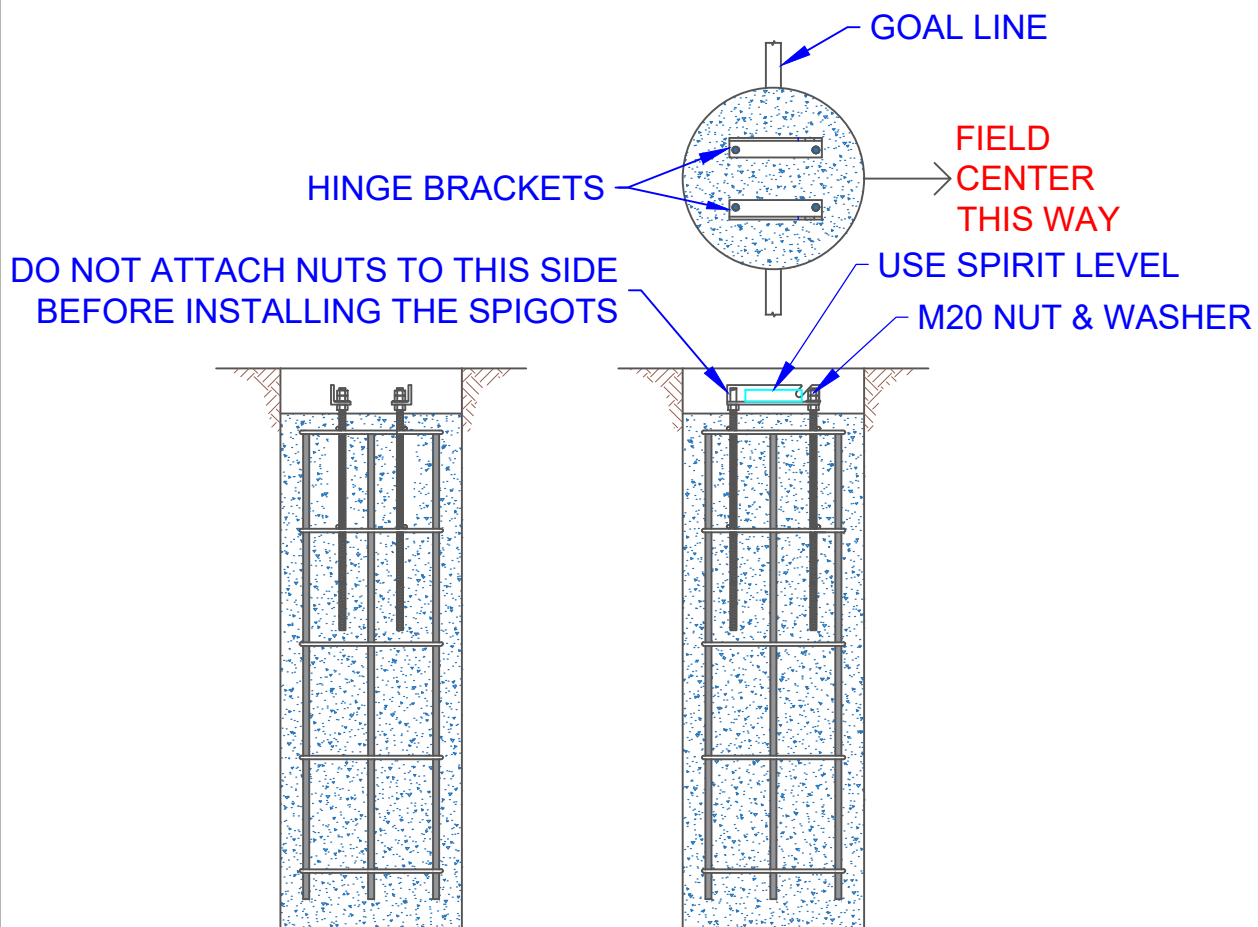
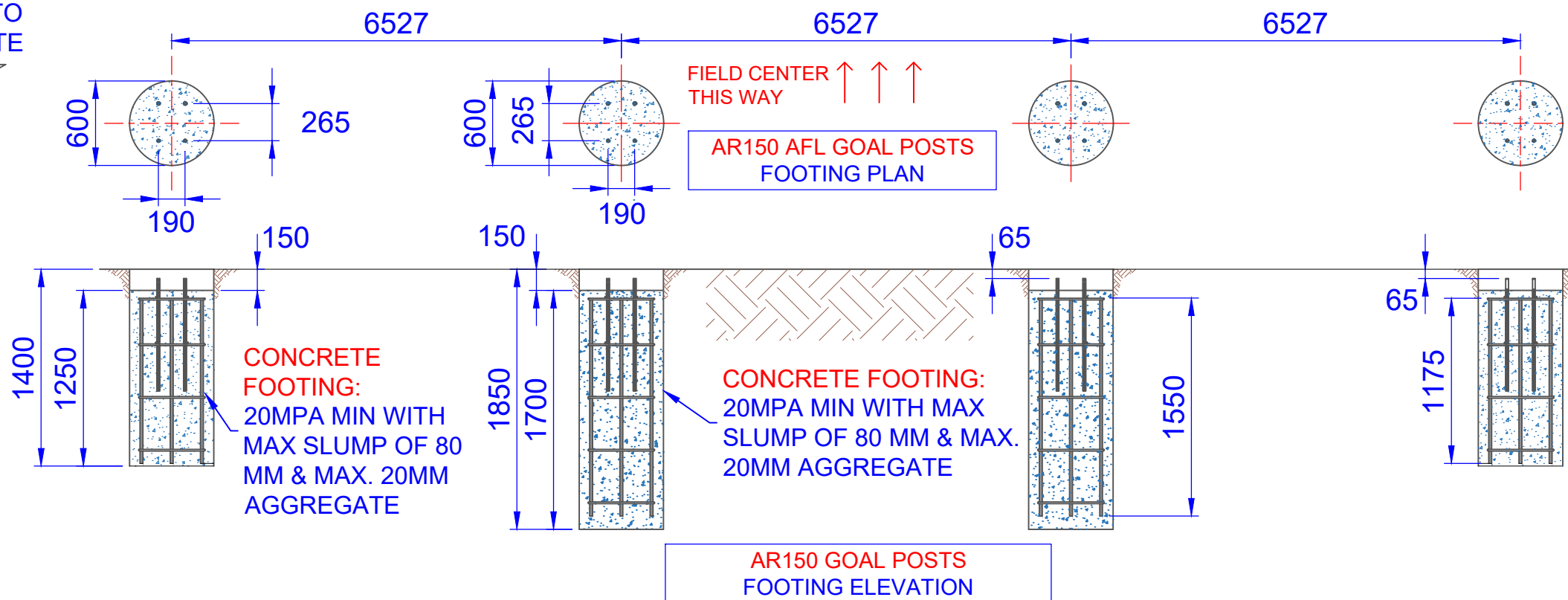
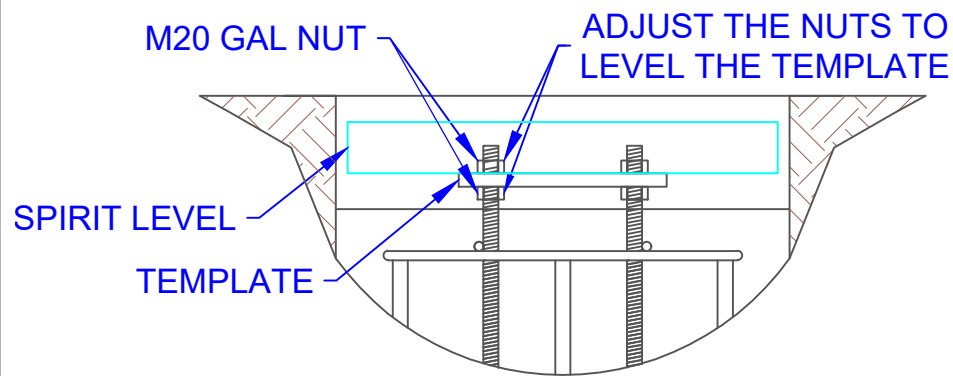

FOOTING INSTALLATION INSTRUCTIONS:
STEP 1: MARK THE POSITION OF THE HOLES FOR FOOTING. USE THE AFL OVAL CENTRE AS A REFERENCE LINE TO ENSURE THE POSTS ARE CENTERED.
STEP 2: THEN CONCRETE THE FOOTING USING SPECIFIED CONCRETE. THE FOOTING SPECIFIED IS FOR STANDARD 'S' & 'M' SOIL ONLY. PLAY HARD SPORTS MUST BE SPECIFIED OF ANY OTHER SOIL CONDITION AND WILL INCUR ADDITIONAL CHARGES FOR RE-ENGINEERING THE FOOTINGS.
 THE THREADED RODS ON THE CAGE MUST BE CORRECTLY ORIENTED TOWARDS THE OVAL CENTRE.
STEP 3: ONCE THE CONCRETE IS SET, ATTACH THE LEFT AND RIGHT HINGE BRACKET TO THE THREADED ROD, POSITIONING THE GROOVE IN THE BRACKET AS SHOWN.

TITLE: AR150 AFL GOAL POSTS ASSEMBLY DETAILS 1 OF 3	
DRAWING NUMBER: AR150	ISSUED ON: 01/08/2024
	
Oz Ring Pty Ltd Trading as: Play Hard Sports Equipment ABN 79 066 094 559 24 Ern Harley Drive Burleigh Heads Qld 4220 Phone: (07) 5593 4494 Fax: (07) 5593 4338 Website: www.playhardsports.com.au Email: email@playhardsports.com.au	